

# NTTD1P02R2

## Power MOSFET -1.45 Amps, -20 Volts

### P-Channel Enhancement Mode Dual Micro8™ Package

#### Features

- Ultra Low  $R_{DS(on)}$
- Higher Efficiency Extending Battery Life
- Logic Level Gate Drive
- Miniature Dual Micro8 Surface Mount Package
- Diode Exhibits High Speed, Soft Recovery
- Micro8 Mounting Information Provided
- Pb-Free Package is Available

#### Applications

- Power Management in Portable and Battery-Powered Products, i.e.: Computers, Printers, PCMCIA Cards, Cellular and Cordless Telephones

#### MAXIMUM RATINGS ( $T_J = 25^\circ\text{C}$ unless otherwise noted)

Rating	Symbol	Value	Unit
Drain-to-Source Voltage	$V_{DS}$	-20	V
Gate-to-Source Voltage – Continuous	$V_{GS}$	$\pm 8.0$	V
Thermal Resistance – Junction-to-Ambient (Note 1)	$R_{\theta JA}$	250	$^\circ\text{C}/\text{W}$
Total Power Dissipation @ $T_A = 25^\circ\text{C}$	$P_D$	0.50	W
Continuous Drain Current @ $T_A = 25^\circ\text{C}$	$I_D$	-1.45	A
Continuous Drain Current @ $T_A = 70^\circ\text{C}$	$I_D$	-1.15	A
Pulsed Drain Current (Note 3)	$I_{DM}$	-10	A
Thermal Resistance – Junction-to-Ambient (Note 2)	$R_{\theta JA}$	125	$^\circ\text{C}/\text{W}$
Total Power Dissipation @ $T_A = 25^\circ\text{C}$	$P_D$	1.0	W
Continuous Drain Current @ $T_A = 25^\circ\text{C}$	$I_D$	-2.04	A
Continuous Drain Current @ $T_A = 70^\circ\text{C}$	$I_D$	-1.64	A
Pulsed Drain Current (Note 3)	$I_{DM}$	-16	A
Operating and Storage Temperature Range	$T_J, T_{stg}$	-55 to +150	$^\circ\text{C}$
Single Pulse Drain-to-Source Avalanche Energy – Starting $T_J = 25^\circ\text{C}$ ( $V_{DD} = -20\text{ Vdc}$ , $V_{GS} = -4.5\text{ Vdc}$ , Peak $I_L = -3.5\text{ Apk}$ , $L = 5.6\text{ mH}$ , $R_G = 25\ \Omega$ )	EAS	35	mJ
Maximum Lead Temperature for Soldering Purposes for 10 seconds	$T_L$	260	$^\circ\text{C}$

Stresses exceeding Maximum Ratings may damage the device. Maximum Ratings are stress ratings only. Functional operation above the Recommended Operating Conditions is not implied. Extended exposure to stresses above the Recommended Operating Conditions may affect device reliability.

1. Minimum FR-4 or G-10 PCB, Steady State.
2. Mounted onto a 2" square FR-4 Board  
(1 in sq, 2 oz Cu 0.06" thick single sided), Steady State.
3. Pulse Test: Pulse Width = 300  $\mu\text{s}$ , Duty Cycle = 2%.



ON Semiconductor®

<http://onsemi.com>

**-1.45 AMPERES**  
**-20 VOLTS**  
**160 m $\Omega$  @  $V_{GS} = -4.5$**

Dual P-Channel

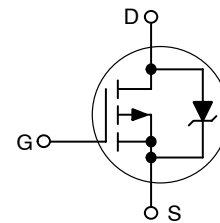

#### MARKING DIAGRAM & PIN ASSIGNMENT

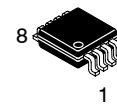

Micro8  
CASE 846A  
STYLE 2

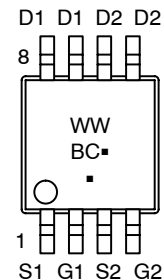

BC = Specific Device Code  
WW = Work Week  
▪ = Pb-Free Package

(Note: Microdot may be in either location)

#### ORDERING INFORMATION

Device	Package	Shipping†
NTTD1P02R2	Micro8	4000/Tape & Reel
NTTD1P02R2G	Micro8 (Pb-Free)	4000/Tape & Reel

†For information on tape and reel specifications, including part orientation and tape sizes, please refer to our Tape and Reel Packaging Specification Brochure, BRD8011/D.

# NTTD1P02R2

## ELECTRICAL CHARACTERISTICS (T<sub>C</sub> = 25°C unless otherwise noted) (Note 4)

Characteristic	Symbol	Min	Typ	Max	Unit
----------------	--------	-----	-----	-----	------

### OFF CHARACTERISTICS

Drain-to-Source Breakdown Voltage (V <sub>GS</sub> = 0 Vdc, I <sub>D</sub> = -250 μAdc) Temperature Coefficient (Positive)	V <sub>(BR)DSS</sub>	-20 -	- -12	- -	Vdc mV/°C
Zero Gate Voltage Drain Current (V <sub>GS</sub> = 0 Vdc, V <sub>DS</sub> = -20 Vdc, T <sub>J</sub> = 25°C) (V <sub>GS</sub> = 0 Vdc, V <sub>DS</sub> = -20 Vdc, T <sub>J</sub> = 125°C)	I <sub>DSS</sub>	- -	- -	-1.0 -10	μAdc
Gate-Body Leakage Current (V <sub>GS</sub> = -8 Vdc, V <sub>DS</sub> = 0 Vdc)	I <sub>GSS</sub>	-	-	-100	nAdc
Gate-Body Leakage Current (V <sub>GS</sub> = +8 Vdc, V <sub>DS</sub> = 0 Vdc)	I <sub>GSS</sub>	-	-	100	nAdc

### ON CHARACTERISTICS

Gate Threshold Voltage (V <sub>DS</sub> = V <sub>GS</sub> , I <sub>D</sub> = -250 μAdc) Temperature Coefficient (Negative)	V <sub>GS(th)</sub>	-0.7 -	-0.95 2.3	-1.4 -	Vdc
Static Drain-to-Source On-State Resistance (V <sub>GS</sub> = -4.5 Vdc, I <sub>D</sub> = -1.45 Adc) (V <sub>GS</sub> = -2.7 Vdc, I <sub>D</sub> = -0.7 Adc) (V <sub>GS</sub> = -2.5 Vdc, I <sub>D</sub> = -0.7 Adc)	R <sub>DS(on)</sub>	- - -	0.130 0.175 0.190	0.160 0.250 -	Ω
Forward Transconductance (V <sub>DS</sub> = -10 Vdc, I <sub>D</sub> = -0.7 Adc)	g <sub>FS</sub>	-	2.5	-	Mhos

### DYNAMIC CHARACTERISTICS

Input Capacitance	(V <sub>DS</sub> = -16 Vdc, V <sub>GS</sub> = 0 Vdc, f = 1.0 MHz)	C <sub>ISS</sub>	-	265	-	pF
Output Capacitance		C <sub>OSS</sub>	-	100	-	
Reverse Transfer Capacitance		C <sub>RSS</sub>	-	60	-	

### SWITCHING CHARACTERISTICS (Notes 5 & 6)

Turn-On Delay Time	(V <sub>DD</sub> = -16 Vdc, I <sub>D</sub> = -1.45 Adc, V <sub>GS</sub> = -4.5 Vdc, R <sub>G</sub> = 6.0 Ω)	t <sub>d(on)</sub>	-	10	-	ns
Rise Time		t <sub>r</sub>	-	25	-	
Turn-Off Delay Time		t <sub>d(off)</sub>	-	30	-	
Fall Time		t <sub>f</sub>	-	25	-	
Turn-On Delay Time	(V <sub>DD</sub> = -16 Vdc, I <sub>D</sub> = -0.7 Adc, V <sub>GS</sub> = -4.5 Vdc, R <sub>G</sub> = 6.0 Ω)	t <sub>d(on)</sub>	-	10	-	ns
Rise Time		t <sub>r</sub>	-	20	-	
Turn-Off Delay Time		t <sub>d(off)</sub>	-	30	-	
Fall Time		t <sub>f</sub>	-	20	-	
Total Gate Charge	(V <sub>DS</sub> = -16 Vdc, V <sub>GS</sub> = -4.5 Vdc, I <sub>D</sub> = -1.45 Adc)	Q <sub>tot</sub>	-	5.0	10	nC
Gate-Source Charge		Q <sub>gs</sub>	-	1.5	-	
Gate-Drain Charge		Q <sub>gd</sub>	-	2.0	-	

### BODY-DRAIN DIODE RATINGS (Note 5)

Diode Forward On-Voltage	(I <sub>S</sub> = -1.45 Adc, V <sub>GS</sub> = 0 Vdc) (I <sub>S</sub> = -1.45 Adc, V <sub>GS</sub> = 0 Vdc, T <sub>J</sub> = 125°C)	V <sub>SD</sub>	- -	-0.91 -0.72	-1.1 -	Vdc
Reverse Recovery Time	(I <sub>S</sub> = -1.45 Adc, V <sub>GS</sub> = 0 Vdc, di <sub>S</sub> /dt = 100 A/μs)	t <sub>rr</sub>	-	25	-	ns
		t <sub>a</sub>	-	13	-	
		t <sub>b</sub>	-	12	-	
Reverse Recovery Stored Charge		Q <sub>RR</sub>	-	0.015	-	μC

4. Handling precautions to protect against electrostatic discharge are mandatory.
5. Indicates Pulse Test: Pulse Width = 300 μs max, Duty Cycle = 2%.
6. Switching characteristics are independent of operating junction temperature.

# NTTD1P02R2

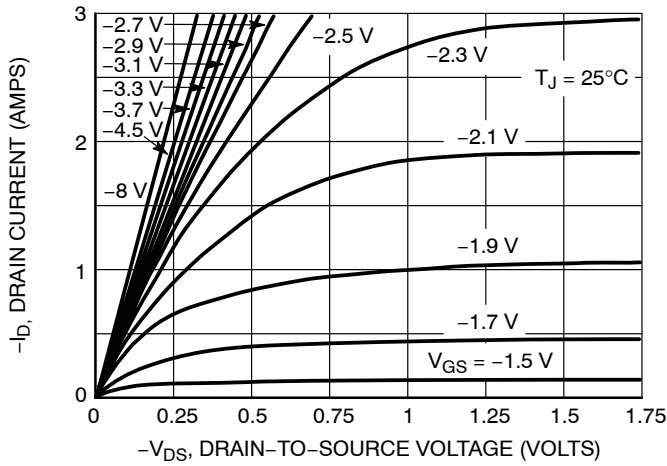

**Figure 1. On-Region Characteristics**

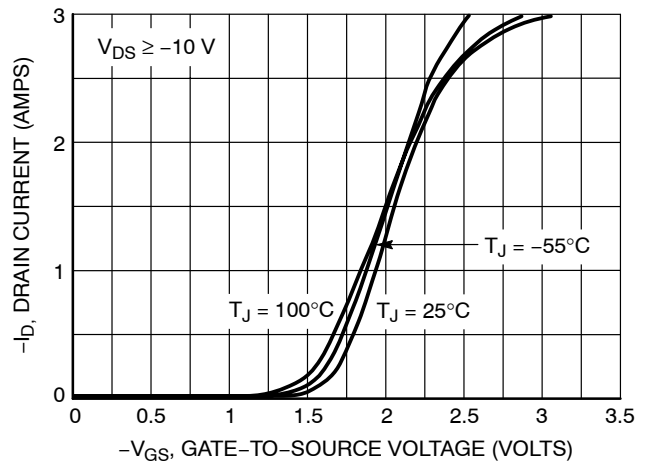

**Figure 2. Transfer Characteristics**

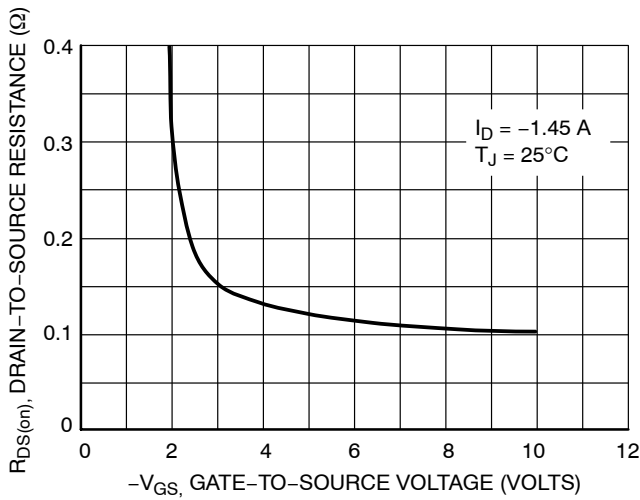

**Figure 3. On-Resistance versus Gate-to-Source Voltage**

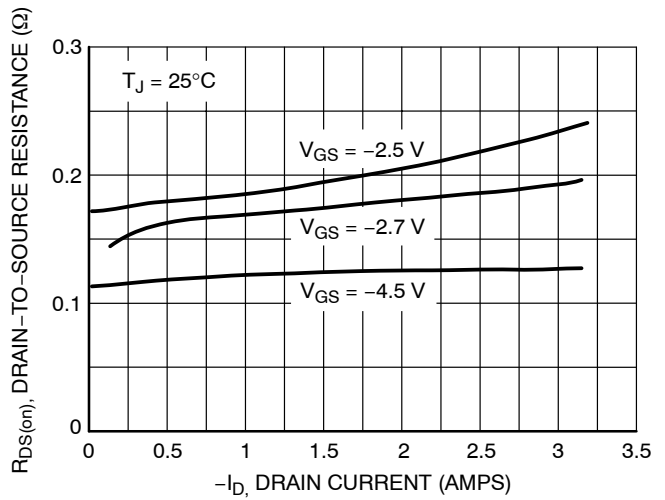

**Figure 4. On-Resistance versus Drain Current and Gate Voltage**

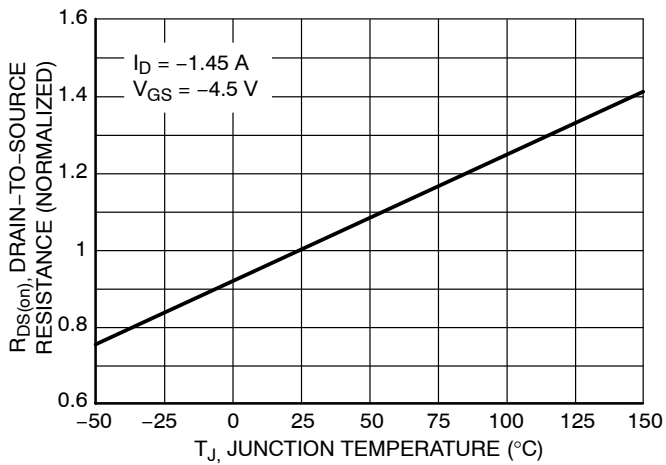

**Figure 5. On-Resistance Variation with Temperature**

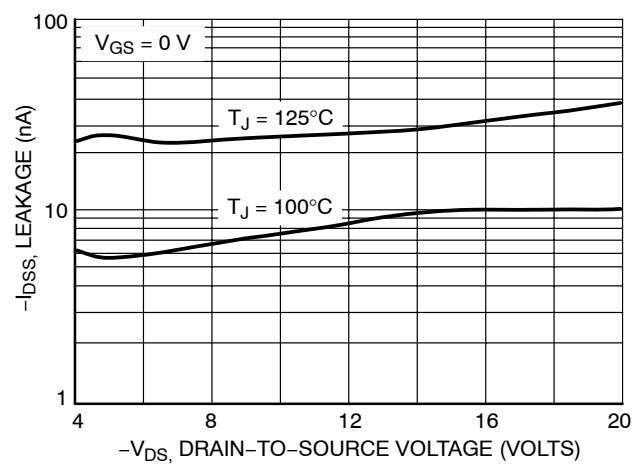

**Figure 6. Drain-to-Source Leakage Current versus Voltage**

# NTTD1P02R2

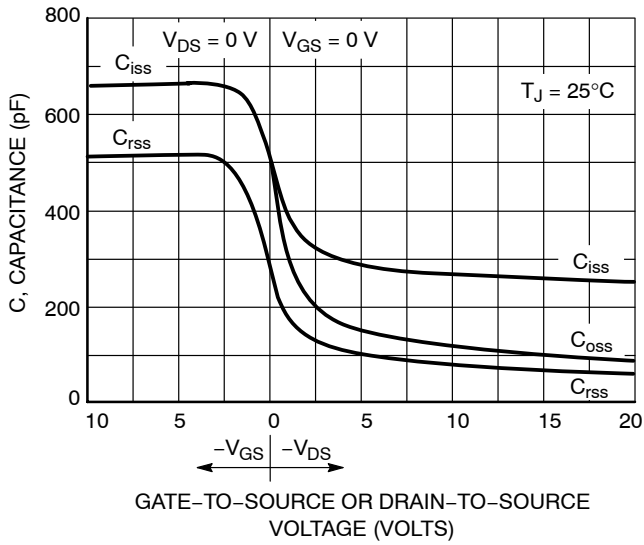

Figure 7. Capacitance Variation

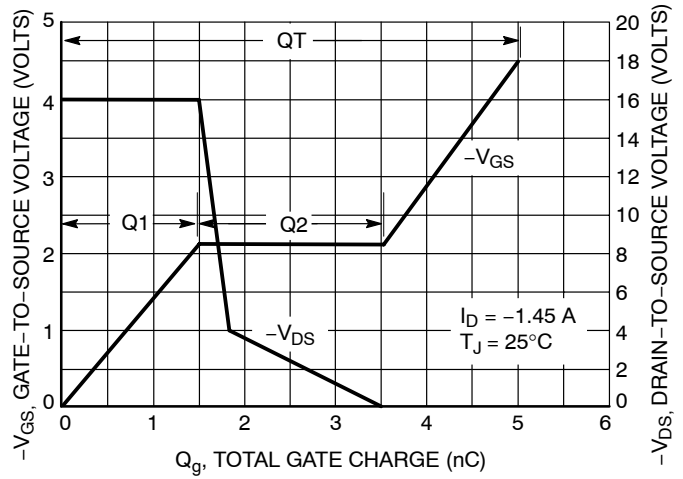

Figure 8. Gate-to-Source and Drain-to-Source Voltage versus Total Charge

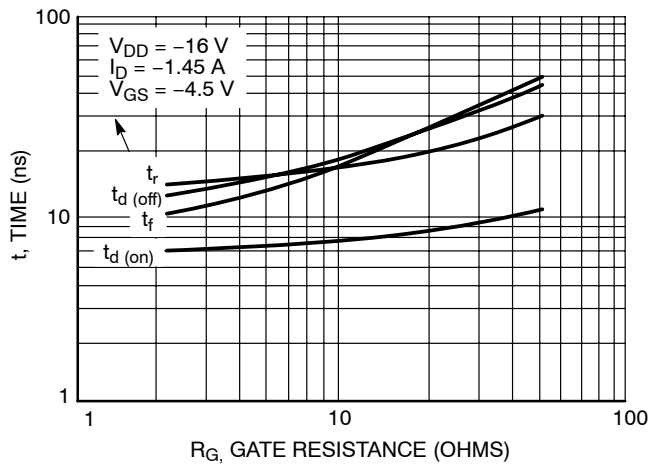

Figure 9. Resistive Switching Time Variation versus Gate Resistance

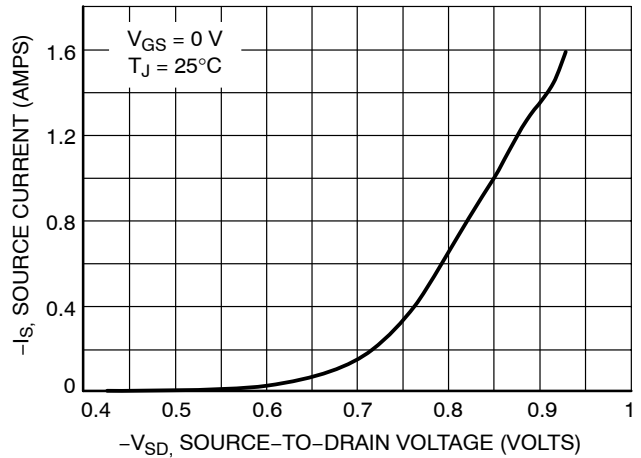

Figure 10. Diode Forward Voltage versus Current

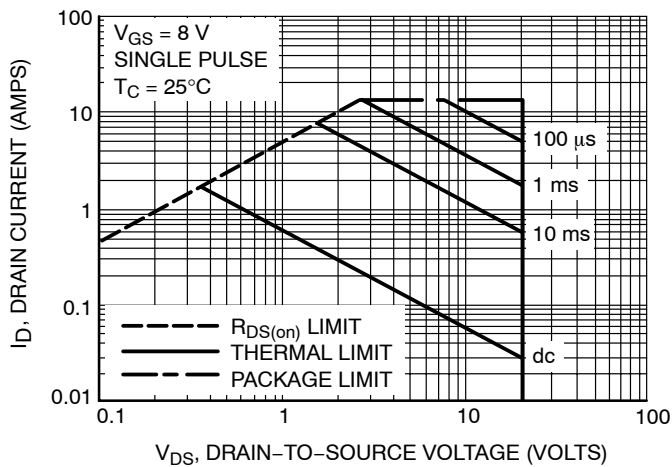

Figure 11. Maximum Rated Forward Biased Safe Operating Area

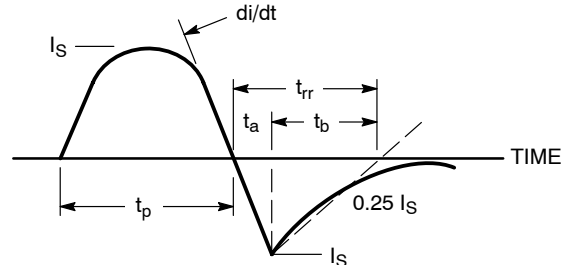

Figure 12. Diode Reverse Recovery Waveform

# NTTD1P02R2

## TYPICAL ELECTRICAL CHARACTERISTICS

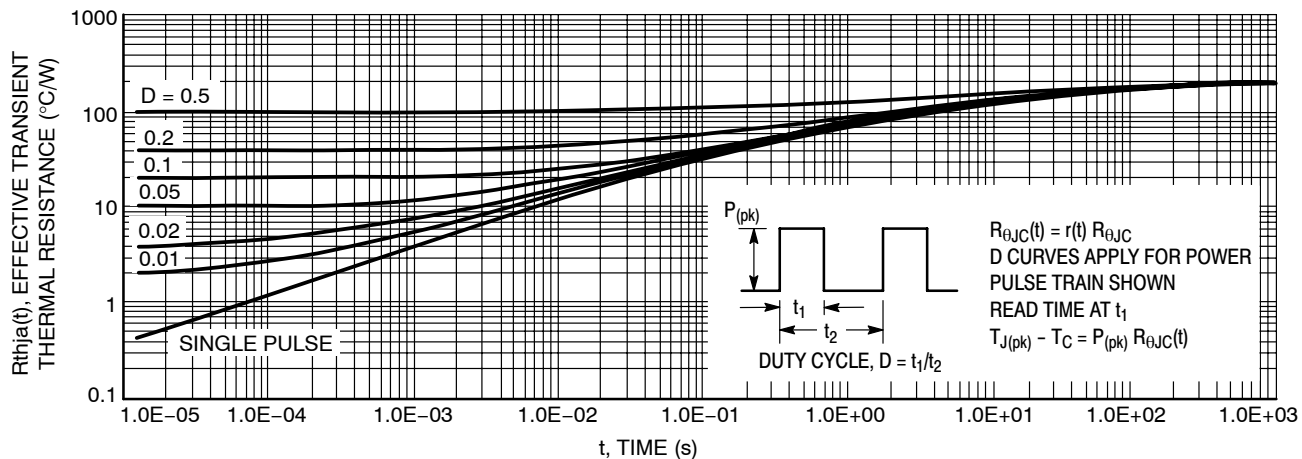
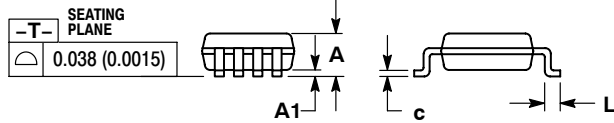
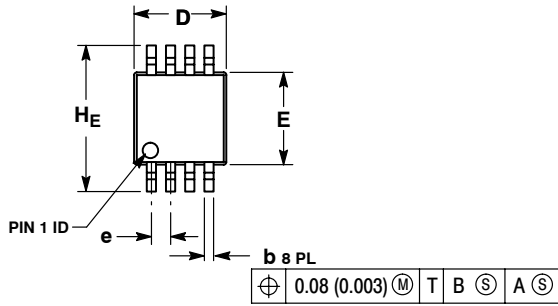

Figure 13. Thermal Response

# NTTD1P02R2

## PACKAGE DIMENSIONS

Micro8™  
CASE 846A-02  
ISSUE G



### NOTES:

1. DIMENSIONING AND TOLERANCING PER ANSI Y14.5M, 1982.
2. CONTROLLING DIMENSION: MILLIMETER.
3. DIMENSION A DOES NOT INCLUDE MOLD FLASH, PROTRUSIONS OR GATE BURRS. MOLD FLASH, PROTRUSIONS OR GATE BURRS SHALL NOT EXCEED 0.15 (0.006) PER SIDE.
4. DIMENSION B DOES NOT INCLUDE INTERLEAD FLASH OR PROTRUSION. INTERLEAD FLASH OR PROTRUSION SHALL NOT EXCEED 0.25 (0.010) PER SIDE.
5. 846A-01 OBSOLETE, NEW STANDARD 846A-02.

DIM	MILLIMETERS			INCHES		
	MIN	NOM	MAX	MIN	NOM	MAX
A	--	--	1.10	--	--	0.043
A1	0.05	0.08	0.15	0.002	0.003	0.006
b	0.25	0.33	0.40	0.010	0.013	0.016
c	0.13	0.18	0.23	0.005	0.007	0.009
D	2.90	3.00	3.10	0.114	0.118	0.122
E	2.90	3.00	3.10	0.114	0.118	0.122
e	0.65 BSC			0.026 BSC		
L	0.40	0.55	0.70	0.016	0.021	0.028
HE	4.75	4.90	5.05	0.187	0.193	0.199

### STYLE 2:

- PIN 1. SOURCE 1
- GATE 1
- SOURCE 2
- GATE 2
- DRAIN 2
- DRAIN 2
- DRAIN 1
- DRAIN 1

### SOLDERING FOOTPRINT\*

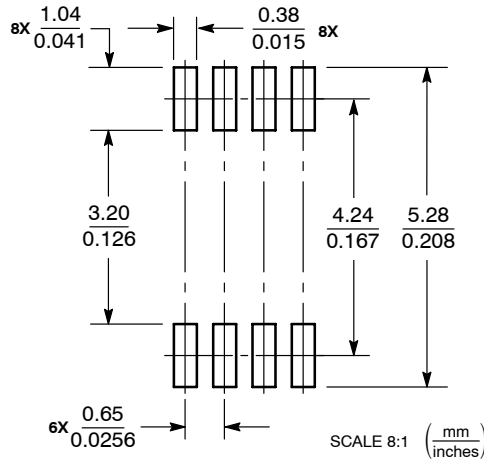

\*For additional information on our Pb-Free strategy and soldering details, please download the ON Semiconductor Soldering and Mounting Techniques Reference Manual, SOLDERRM/D.

Micro8 is a registered trademark of International Rectifier Corporation.

ON Semiconductor and are registered trademarks of Semiconductor Components Industries, LLC (SCILLC). SCILLC reserves the right to make changes without further notice to any products herein. SCILLC makes no warranty, representation or guarantee regarding the suitability of its products for any particular purpose, nor does SCILLC assume any liability arising out of the application or use of any product or circuit, and specifically disclaims any and all liability, including without limitation special, consequential or incidental damages. "Typical" parameters which may be provided in SCILLC data sheets and/or specifications can and do vary in different applications and actual performance may vary over time. All operating parameters, including "Typicals" must be validated for each customer application by customer's technical experts. SCILLC does not convey any license under its patent rights nor the rights of others. SCILLC products are not designed, intended, or authorized for use as components in systems intended for surgical implant into the body, or other applications intended to support or sustain life, or for any other application in which the failure of the SCILLC product could create a situation where personal injury or death may occur. Should Buyer purchase or use SCILLC products for any such unintended or unauthorized application, Buyer shall indemnify and hold SCILLC and its officers, employees, subsidiaries, affiliates, and distributors harmless against all claims, costs, damages, and expenses, and reasonable attorney fees arising out of, directly or indirectly, any claim of personal injury or death associated with such unintended or unauthorized use, even if such claim alleges that SCILLC was negligent regarding the design or manufacture of the part. SCILLC is an Equal Opportunity/Affirmative Action Employer. This literature is subject to all applicable copyright laws and is not for resale in any manner.

### PUBLICATION ORDERING INFORMATION

**LITERATURE FULFILLMENT:**  
Literature Distribution Center for ON Semiconductor  
P.O. Box 61312, Phoenix, Arizona 85082-1312 USA  
**Phone:** 480-829-7710 or 800-344-3860 Toll Free USA/Canada  
**Fax:** 480-829-7709 or 800-344-3867 Toll Free USA/Canada  
**Email:** orderlit@onsemi.com

**N. American Technical Support:** 800-282-9855 Toll Free  
USA/Canada

**Japan:** ON Semiconductor, Japan Customer Focus Center  
2-9-1 Kamimeguro, Meguro-ku, Tokyo, Japan 153-0051  
**Phone:** 81-3-5773-3850

**ON Semiconductor Website:** <http://onsemi.com>

**Order Literature:** <http://www.onsemi.com/litorder>

For additional information, please contact your local Sales Representative.